

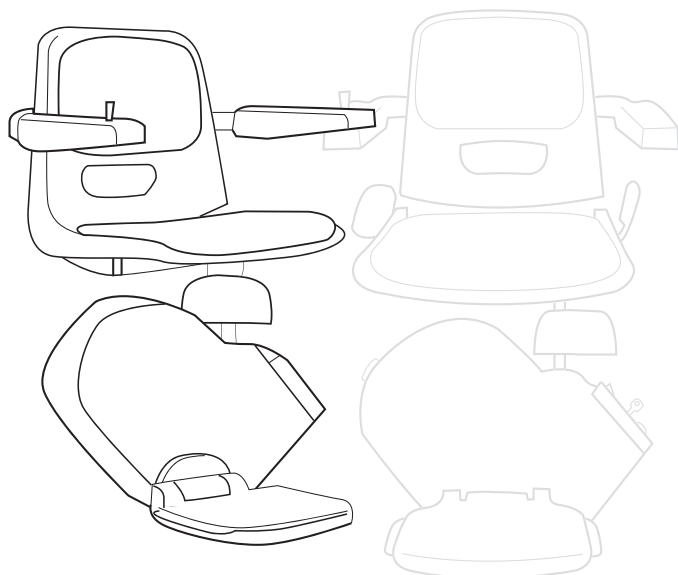

ACORN STAIRLIFTS

THANK YOU

Thank you for choosing ACORN. You can rest assured that your stairlift will provide many years of reliable service and allow you to enjoy full use of your home.



Your stairlift is covered by a manufacturer's guarantee for 12 months that covers the cost of replacement parts (however, problems arising as a result of misuse of the equipment are not covered by the guarantee).

Your stairlift is expertly designed and manufactured to the very highest standards. Regular maintenance is required to ensure safe and trouble-free service.

**Before using your stairlift,
please read these instructions carefully.**

THE STAIRLIFT

The **ACORN Superglide** is an electrically powered stairlift designed for domestic use. If used correctly, it will provide many years of safe, reliable service.

It is designed to carry one person weighing no more than 127kg (280lbs, 20 stones).

The **ACORN Superglide** is powered by an internal battery pack that is charged from the residential mains supply / wall outlet via a transformer that reduces the mains voltage to a safe level. This means that there is no hazard from electric shock and also that the stairlift will continue to function even if the mains electricity supply is interrupted.

- ① Folding armrest
- ② Status display
- ③ Joystick control (Toggle switch)
- ④ Seat swivel lever
- ⑤ Key switch
- ⑥ Folding seat base
- ⑦ Safety sensor
- ⑧ Battery isolation switch
- ⑨ Footrest anti-slip surface
- ⑩ Folding footrest
- ⑪ Safety sensor up
- ⑫ Seat Belt (optional)
- ⑬ Infra red sensors

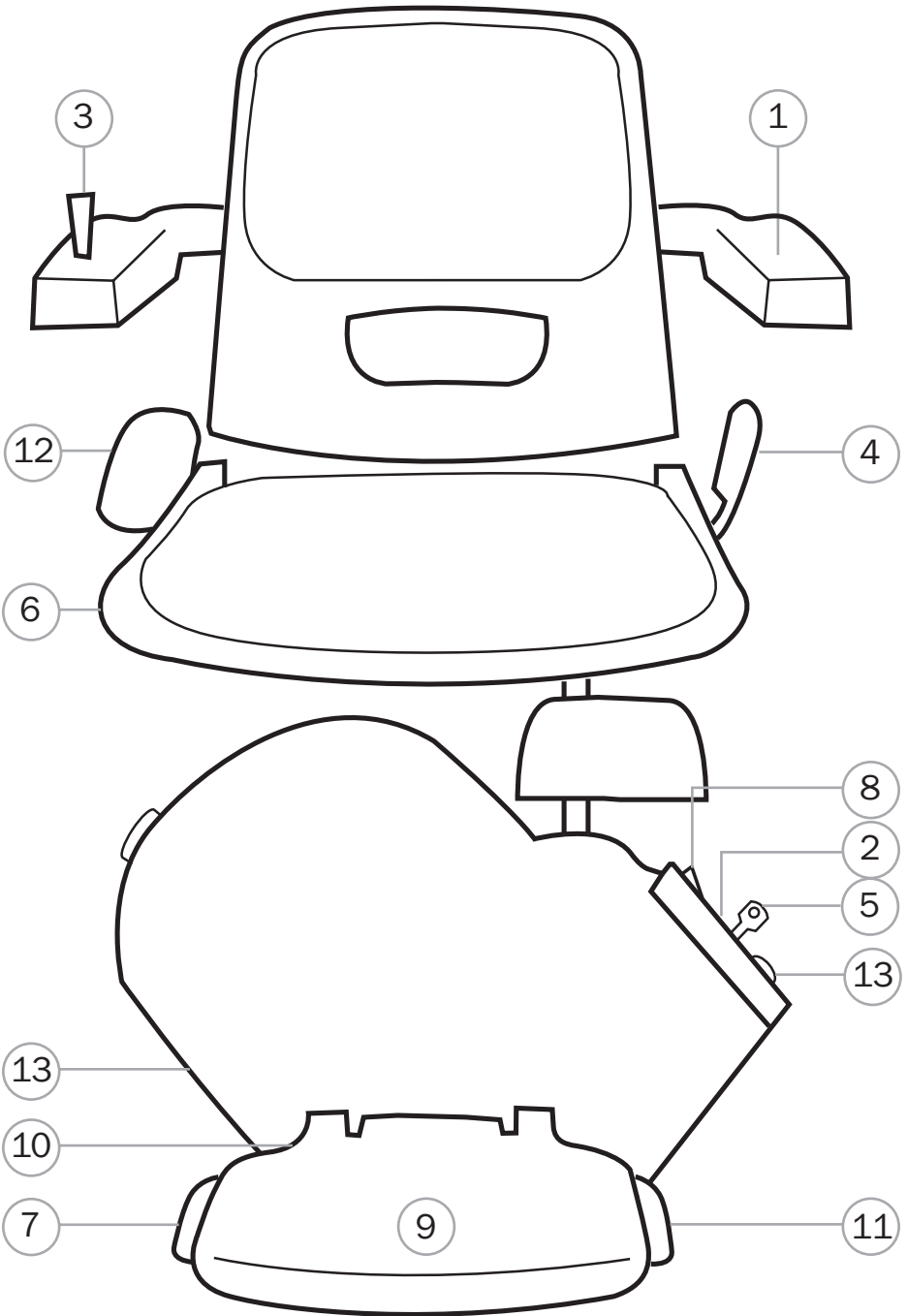

GENERAL NOTES ON SAFETY

- Ensure that the stairway is not being used by others and is clear of articles or obstructions before using the stairlift.
- Relax and sit well back in the seat with your arms on the armrests and your feet well back on the footrest.
- If an inertia type lap belt is fitted, fasten securely.



DANGER! The stairlift is designed to carry one person at a time. Never attempt to carry more than one person.

DANGER! Do not allow children to play with the stairlift. Use by children should always be supervised. For safety, it is advisable to switch off the stairlift and remove the key if there is a risk of tampering by children.



Ensure other members of your household or visitors are aware that the stairlift is in use, making them aware of any potential trip hazards.

Ensure that household pets are out of harms way before using the stairlift.

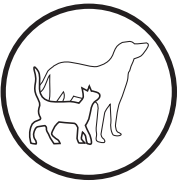

DANGER! Ensure that there are no articles of your clothing that could become entrapped in the stairlift mechanism, as this could result in personal injury and/or damage to the equipment. Always check that your clothing is clear of the rail and carriage assemblies before using the stairlift.

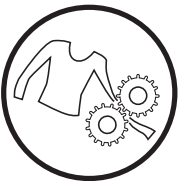

CAUTION! It is possible for small items to be dropped onto the stairlift rail and then slide down the rail and into the stairlift mechanism. If you suspect that any foreign object has become trapped in the equipment, consult your ACORN representative before further use.

WARNING! To disconnect the AC power supply from the stairlift system, switch off the power and remove the transformer from the wall socket/outlet. Switch off the battery isolation (No. 8 on page 3) from the carriage unit to prevent battery drain.

OPERATION

KEY SWITCH



You will find the key switch on the carriage cover.

For the unit to operate, the key must be inserted and turned to the right (clockwise).



The display panel, positioned next to the key, will indicate .

If the display is not indicating  please check the DIGITAL DISPLAY CODES on pages 13 and 14.

However, when the key is turned to the left or withdrawn, the display panel will show  and the unit will not run.

The key can also be removed to prevent any unauthorised use.
This will not affect the charging.

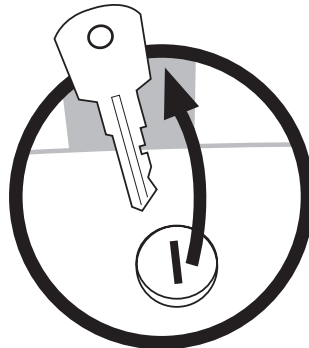

TOGGLE SWITCH

The toggle switch is located on the chair arm.

To operate the unit, the toggle must be pressed and held in the desired direction of travel.

There will be an **audible beep** to signal that a command has been received.

The unit will only operate while the toggle is being pressed, and will stop automatically when the unit reaches the end of the track or the toggle is released.

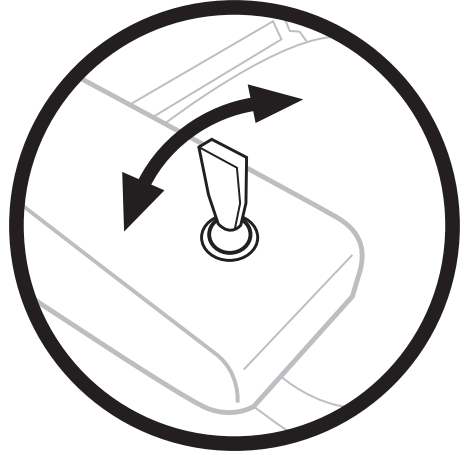

If a beep cannot be heard when the toggle is pressed, check the display code and refer to the DIGITAL DISPLAY CODES (pages 13/14).

REMOTE CONTROLS



The unit may also be operated with the remote control handset. There are two buttons on the handset.

To send the unit up, press and hold the **red button**. To send it down, press and hold the **green button**. The unit will stop automatically at the end of the track or if the button is released.

The unit will operate with the seat arms, seat pad or footrest in the folded position. However, it will not work if the seat has been turned (or the safety arm has been left up). This will be indicated by  on the display panel.

Occasional interference from outside sources may in some instances cause the lift to stop. This is a normal feature, designed to prevent accidental operation. The remote will require the button to be released and pressed again.

It is recommended that the battery in the handset is changed every 6 months.

SWIVEL SEAT

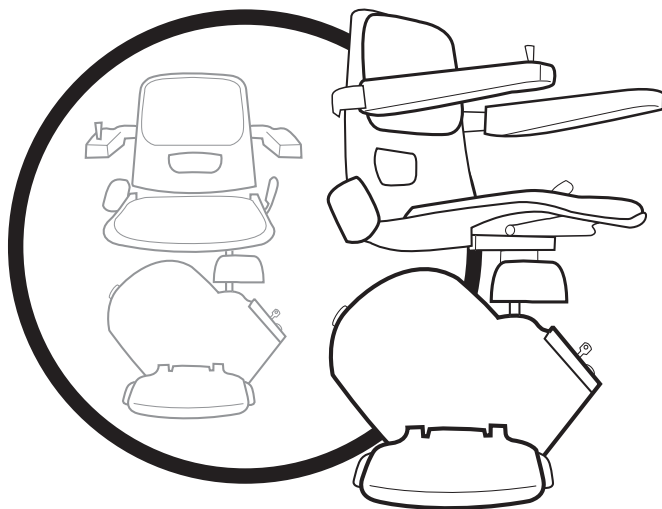



When the unit reaches the upper end of the track, it will stop automatically.

The seat may now be turned to make getting on and off the stairlift easier.

To turn the seat, depress and hold down the locking lever at the side of the seat pad.

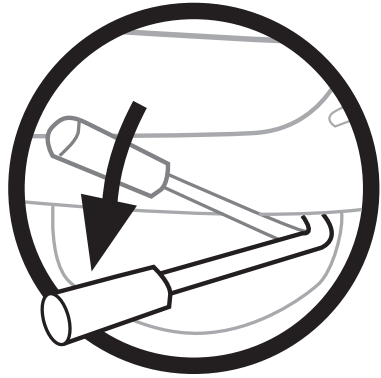
This will then allow the seat to be rotated to face the staircase landing. The seat will lock at 45° and 90° from the travel position.



The unit will not operate further until the seat has been rotated back to the travel position. Failure to do so will indicate  on the display panel.

Safety note: The footrest does not swivel, and the seat only swivels at the top of the stairs.

Make sure the seat is locked into position before getting on or off.

SEAT BELT (Optional-UK)

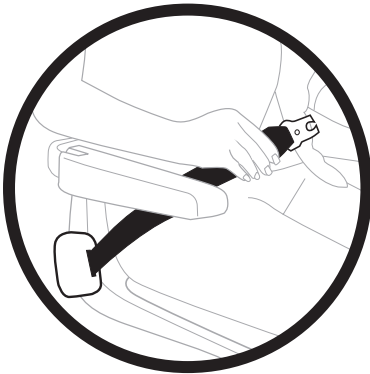

To fasten the seat belt, pull out the belt and insert the clasp into the buckle. A positive click should be heard, indicating that the lock has engaged properly.

To release the seat belt, hold the belt with one hand and press the release button on the buckle. The clasp will automatically release and allow the belt to retract.



It is important that the belt is held while it retracts, otherwise it will retract too fast, resulting in the belt whipping and may cause injury.

FOLDING SEAT/FOOTREST

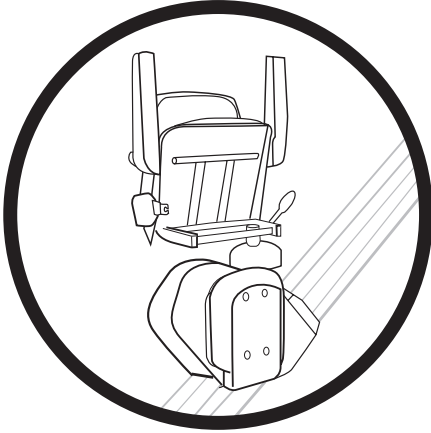

The seat, arms and footrest can be folded up when not in use to allow greater access on the stairway, efficiently using the space in your hallway.

The lift can be operated via the remote controls.

PARKING/RECHARGING

When not in use, it is vital that the unit is left at the correct position on the track.

This will depend on which type of track is fitted.

The mains electricity supply/ transformer should be left permanently connected and switched on.

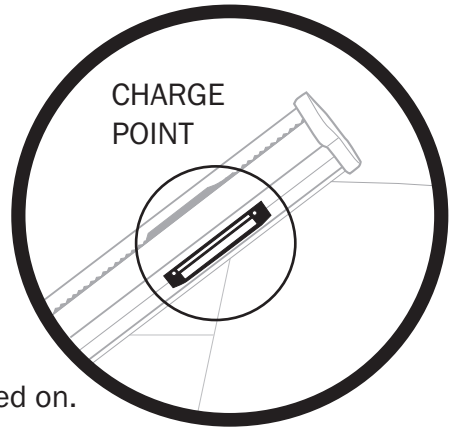

On a STANDARD TRACK, the correct positions are at the top or bottom where the unit stops automatically. At these positions, the unit receives a power supply from the mains / transformer that allows the unit to recharge its internal batteries.

The lift will make a single beep to indicate that a charge point has been reached.

DISCONNECTING THE POWER

If the unit is not to be used for a considerable amount of time e.g: holidays/vacations, etc., you may prefer to disconnect the unit from the mains.

Please note: the following procedure must be followed to avoid battery failure, which is not covered by the manufacturer's warranty.

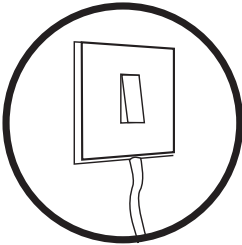

1. **Switch off the mains supply. Remove the transformer from the wall outlet.** (The unit will now make a constant beep, this is the no charge warning)

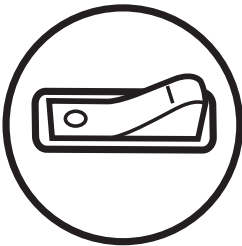

2. **Switch off the battery isolation on the carriage.** (Located next to the key and display on the carriage unit)

Switching off the battery isolation disconnects the batteries, preventing them from discharging.

LIFT WILL NOT RUN

In the unlikely event that a problem should occur, take note of the fault code displayed and contact your dealer.

DEALER STAMP

SAFETY FEATURES

The stairlift comes with an array of safety features fitted as standard.

These include:

Carriage safety pads, upper and lower.

Stops unit on contact with obstruction on track

Footrest safety edges, upper and lower.

Stops unit on contact with obstruction on stairway

Swivel seat switch.

Prevents accidental movement of the stairlift with the seat swivelled

Final limit switch.

Prevents over travel

Over speed governor and safety gear.

Prevents uncontrolled descent

No charge warning.

Audible warning sound



If one or more of the safety devices are activated an appropriate code will be indicated on the display panel. These codes can be found in the DIGITAL DISPLAY CODES (pages 13 and 14) together with the appropriate action to take.

OVER SPEED GOVERNOR

The lift is fitted with a safety device (o.s.g.) that will lock the lift to the rail in the event of a mechanical failure or excessive speed. If the o.s.g operates spuriously either due to excessive shock or vibration, indicated by  on the display panel, it is possible to hand wind the lift to reset it.















HAND WINDING

To hand wind the lift, the following must be observed. **WARNING!**
When hand winding, always observe for possible obstructions.













1. Turn off the battery isolation switch.
2. Remove the blanking grommet and insert the winding handle onto the motor spindle.
3. Turn the winding wheel in a clockwise direction so the lift moves up the track approximately 1 inch.
4. Remove the winding wheel and turn on the battery isolation switch.
5. Check the digital display panel has changed from  to . If it still shows a  repeat steps 1 to 4.
6. Run the lift up until it stops automatically, and then down to check all operations are running as they should. Replace the blanking grommet.

CAUTION! Never run the lift with the winding handle in the lift as it could result in serious injury or damage. Never wind the lift counter clockwise / anti-clockwise if the fault code  shows as this will result in damage to the o.s.g. (if in doubt, contact your ACORN dealer representative for technical advice).

DIGITAL DISPLAY CODES

DISPLAY	FAULT	POSSIBLE SOLUTION
	POWER DOWN (no display)	 Check that the power ON / OFF is in the ON position.
	NORMAL	 If there is a toggle fault, try the remote control handset. A limit switch may be stuck in.
	NO CHARGE	 The mains supply has been turned off or the lift is not at the charging point. There will also be an audible warning sound.
	O.S.G. (see hand winding)	 Hand wind the lift up to RESET the O.S.G.
	SEAT TURNED	 Turn the seat back to the TRAVEL position. The safety arm (if fitted) is not down.
	KEY OFF	 Check that the key is in and turned clockwise.
	FINAL LIMIT	Overrun. Wind the lift up or down.
	FOOTPLATE DOWN	 The downside safety edge is activated. Check downside safety edge. Check footrest base switch.

DIGITAL DISPLAY CODES

DISPLAY	FAULT	POSSIBLE SOLUTION
	FOOTPLATE UP	 Upside safety edge activated.
	CARRIAGE UP	Safety cover up pad activated.
	CARRIAGE DOWN	Safety cover down pad activated.
	BATTERIES	 The batteries are flat. Leave at the charge point for approximately 1 hour.
	BRAKE	 Brake fault. Try a reset. Possible low batteries; try leaving on charge first.
	MOTOR	 Try a reset. If this doesn't work, you will require an engineer to visit. To reset, turn the power switch off (located on the stairlift) for 30 seconds (see page 16).
	BATTERIES	 Batteries low (17 volts or less) re-charge batteries.
	RELAY FAULT	Try a reset. If this does not clear the display and the lift fails to operate, call your ACORN representative for further instructions.

CARE & MAINTENANCE

REMOTE CONTROLS

As previously described, there may be occasions when the remote control units will lose programming due to outside interference. If this happens, you can reset your remote control by sending the carriage to the bottom of the track. Then turn the seat so that the digital display is showing . Press the toggle on the chair arm in the **downward position** (even though the chair will not go down any further), at the same time pressing the **red button** on the remote control for approximately **5 seconds**. When the seat is turned into the correct position, the remote controls will be correctly programmed.



The infrared remote controls work by using an invisible light source. This naturally occurring light source can also be emitted by certain types of low energy bulbs. If it is found that such a bulb is causing interference with the remotes, it is recommended that it be changed to a standard one.

RAILS

It is recommended that the rail should be cleaned on a weekly basis. This should be done with a dry cloth and you can use simple household polish. **Under NO CIRCUMSTANCES should you use a DAMP CLOTH or ABRASIVE.** Failure to clean the track on a regular basis will lead to a build up of dust on the internal rollers of the lift, which will in turn leave black marks and in some instances will leave a residue which can look similar to metal shavings.

It is also recommended that the steel-toothed rack, mounted on the rail itself, should be vacuumed out on a regular basis.

SAFETY EDGES

Should the stairlift become un-operational (displaying ,  or ) this could be due to one of the safety edges being trapped. This can be overcome by simply tapping the relevant safety edge gently. If this doesn't rectify the problem contact your ACORN representative.

OTHER

If the stairlift 'appears' to beep once on a regular cycle (approximately once every minute), please check that this is not actually a smoke alarm, located elsewhere, which is giving off a low battery warning.

RESET

On certain occasions, it may be necessary to reset the control board on the lift.

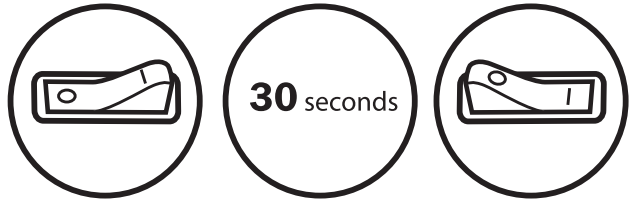

Switch the power off, leave for 30 seconds, then switch back on. This will reset the fault codes in the displays.

WIRING DIAGRAM

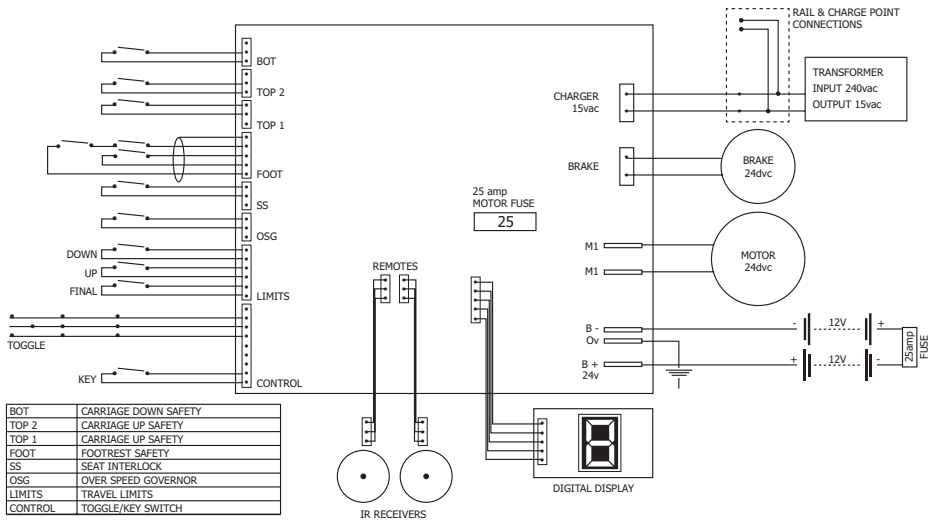

Head Office:
 Telecom House
 Millennium Business Park
 Station Road, Steeton
 West Yorkshire
 BD20 6RB
 United Kingdom

Any details given in these instructions are subject to change without notice.

The illustrations contained in these instructions may vary slightly from the actual product.

info@acornstairlifts.com
www.acornstairlifts.com

